

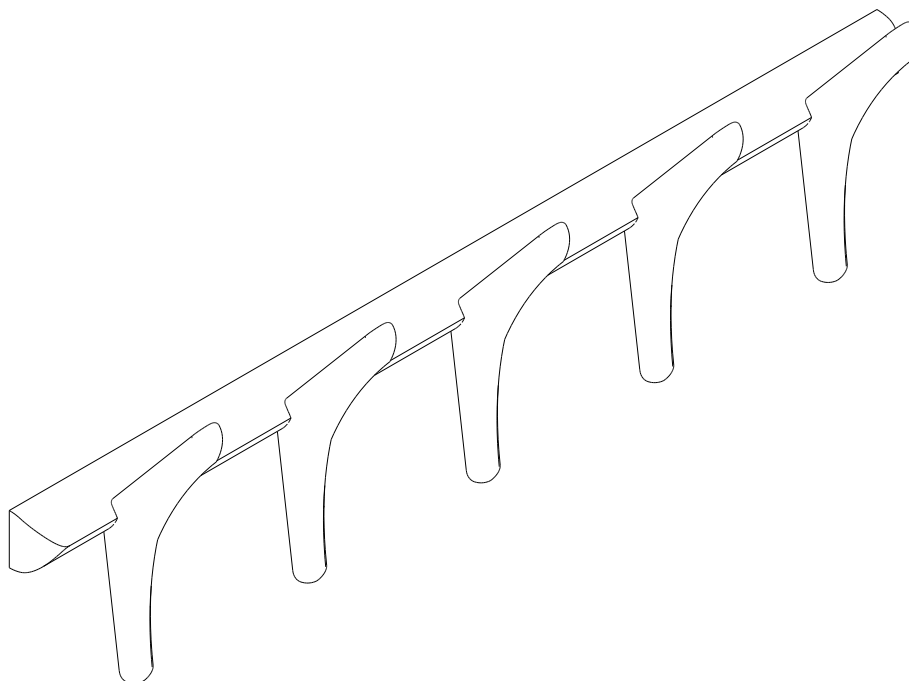

## PI WALL COAT RACK

CODE	DESCRIPTION
29782	PI WALL COAT RACK - VARNISHED MAHOGANY DARK BROWN 70/10/21
29872	PI WALL COAT RACK - VARNISHED SYCAMORE 70/10/21



# Ethnicraft

## PI WALL COAT RACK

### ASSEMBLY INSTRUCTIONS FOR WALL COAT RACK INSTALLATION



#### NOTE

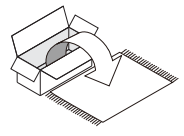

CAREFULLY OPEN THE CARTON, REMOVE CONTENTS AND LAY OUT ON THE FLATTENED BOX, A CARPETED AREA, OR ANOTHER PROTECTIVE SURFACE TO AVOID DAMAGE WHILE ASSEMBLING.



CHECK THE PACKAGE CONTENTS TO ENSURE ALL NECESSARY HARDWARE AND PARTS ARE INCLUDED AND UNDA MAGED. DO NOT USE DAMAGED OR DEFECTIVE PARTS. IF ANY PARTS OR HARDWARE ARE MISSING, CONTACT ETHNICRAFT.

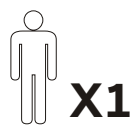

READ THE ASSEMBLY INSTRUCTIONS CAREFULLY BEFORE STARTING, AND FOLLOW THEM STEP BY STEP. IF YOU ARE UNFAMILIAR WITH THIS TYPE OF INSTALLATION OR HAVE ANY SAFETY CONCERNS, SEEK PROFESSIONAL ADVICE.



IT IS RECOMMENDED TO ASSEMBLE WITH AT LEAST ONE OTHER PERSON.

MAXIMUM LOAD PER HANGER IS 5 KG

#### PARTS TO ASSEMBLE

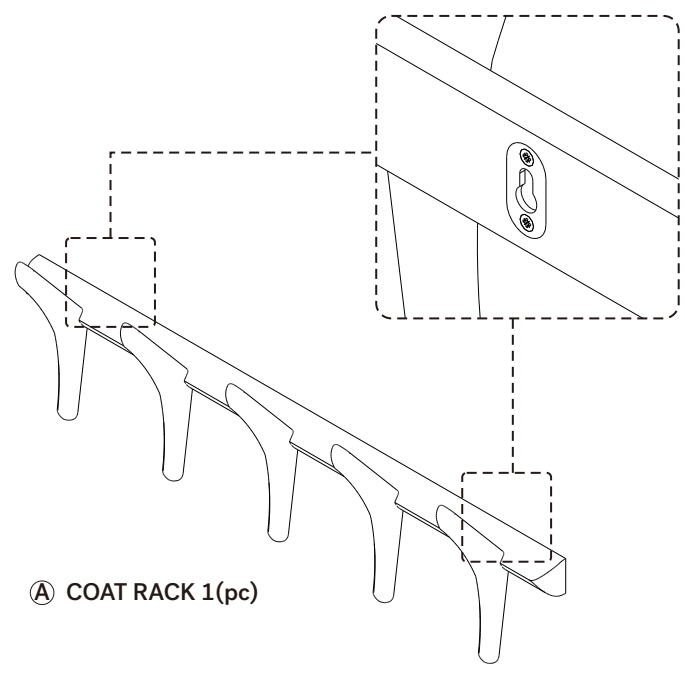

A COAT RACK 1(pc)

B DRILLING JIG 1(pc)

#### HARDWARE ENCLOSED (Included in package)

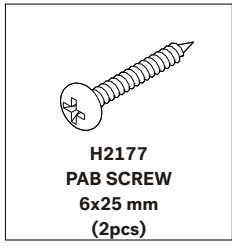

H217  
PAB SCREW  
6x25 mm  
(2pcs)

#### HARDWARE REQUIRED (Not included in package)

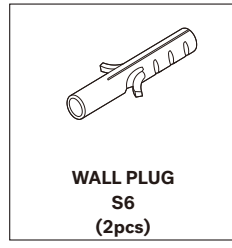

WALL PLUG  
S6  
(2pcs)

#### TOOLS REQUIRED (Not included in package)

PHILLIPS SCREWDRIVER	DRILL	PENCIL	LEVEL

#### SYMBOLS



DIRECTION

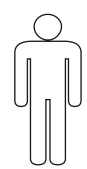

NUMBER OF PERSONS NEEDED

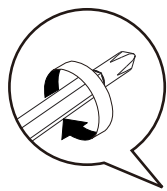

USE PHILLIPS SCREWDRIVER TO TIGHTEN

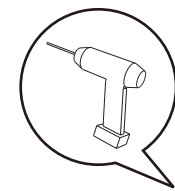

USE DRILL

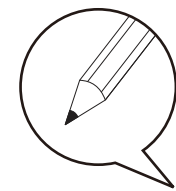

USE PENCIL

# Ethnicraft

## PI WALL COAT RACK

### ASSEMBLY INSTRUCTIONS FOR WALL COAT RACK INSTALLATION



#### A. INSTALLING SCREWS INTO THE WALL

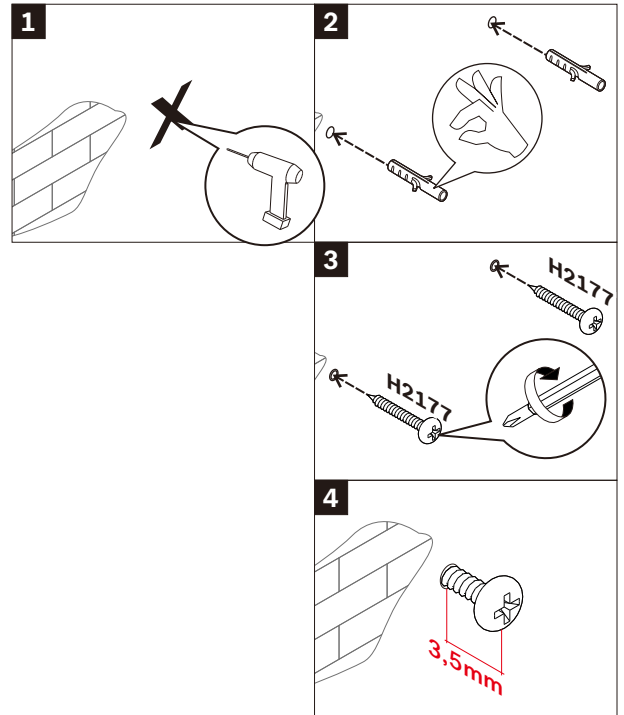
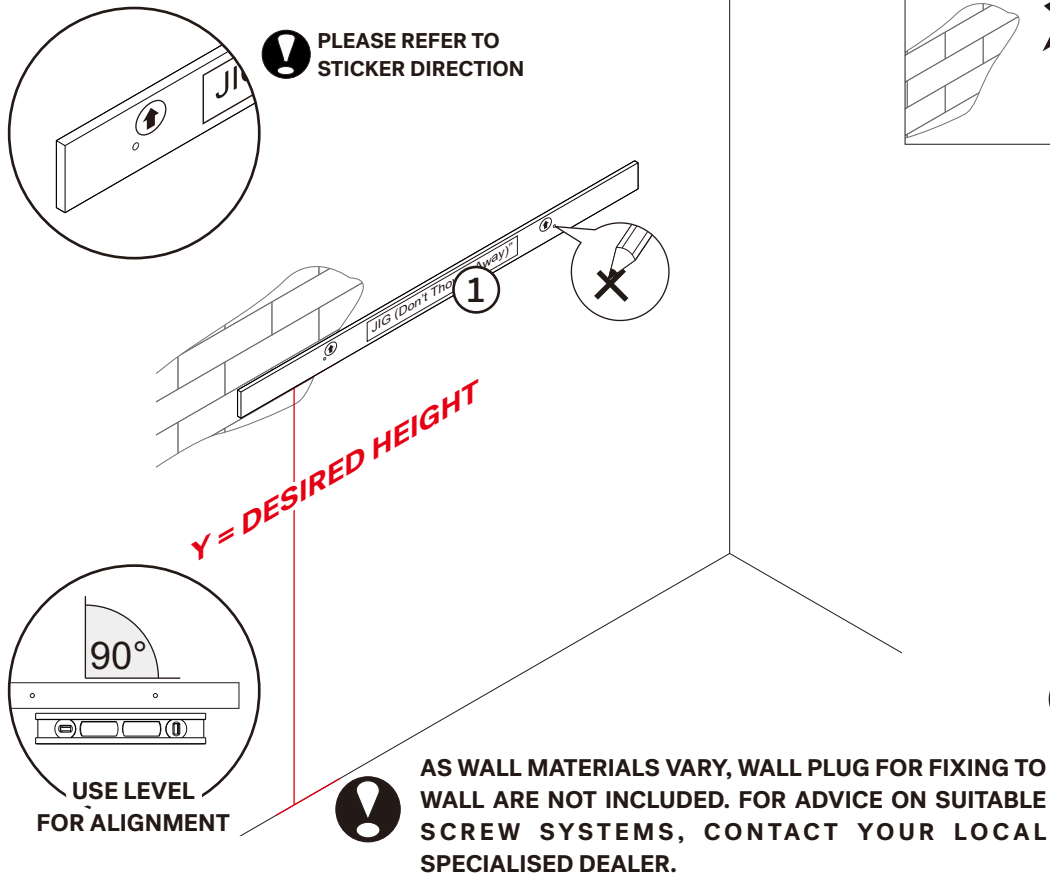

- USE WALL PLUG S6 (2X)
- USE SCREW 6x25 mm (2X)
- LEAVE A GAP OF  $\pm 3.5$ mm BETWEEN THE SCREW AND THE WALL.

#### B. INSTALLING COAT RACK

